

**PENDANT INSTALLATION INSTRUCTIONS**

- Have your pendant installed by a qualified registered electrician.
- Ensure the main power supply is switched off.
- Prepare everything in a clear area.
- Unpack all the components and assemble the lamp holder.
- Shades can be added once the lamp holder is installed if preferable.
- Install the mounting bracket from the ceiling rose onto the ceiling by using the wall plugs and screws.
- Use a screwdriver to loosen the grub screw on the ceiling rose's cord grip.
- Adjust the power cord to the desired length then thread it up into the ceiling rose's cord grip and tighten the grub screw again.
- Connect the main power supply wires to the terminal block (brown – live, blue – neutral, green/yellow – earth) making sure all connections are tight.
- Install ceiling rose onto the mounting bracket and secure by tightening the screws on the sides.
- Install the bulb into lamp holder.
- Secure shade (if relevant) by screwing the bottom shade ring up the lamp holder beneath the shade, if you have not already fully assembled the pendant.
- Reconnect power supply.
- Light Source E27 60W Max.

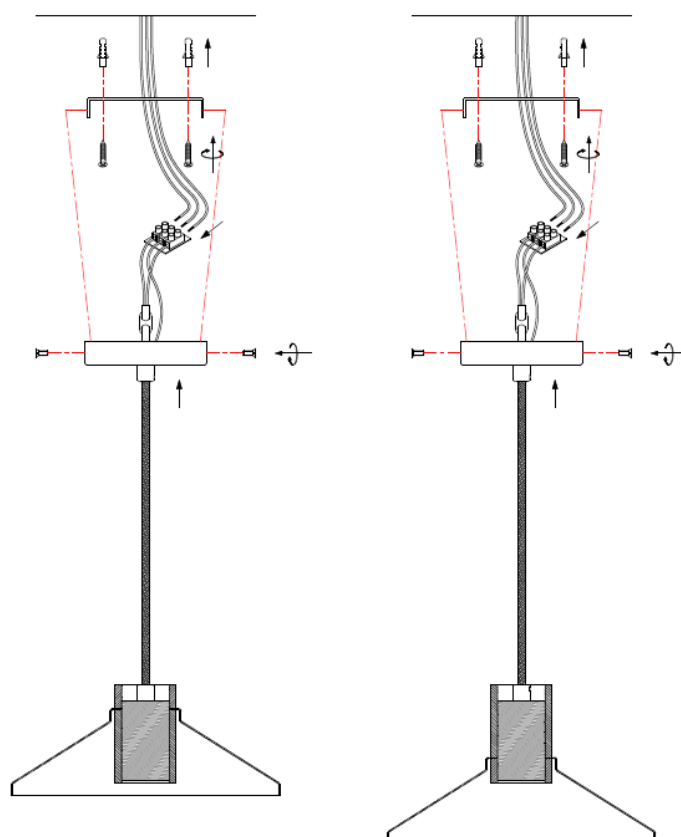

# LAMP HOLDER ASSEMBLY INSTRUCTIONS

We have developed a 'Universal' threaded lamp holder that you customize with different ring sets.

These ring sets thread onto the central threaded lamp holder.

The design philosophy is to cover the cord grip at the top of the lamp holder for a sleek and clean look.

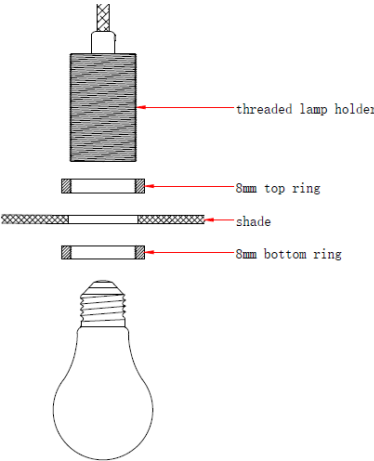
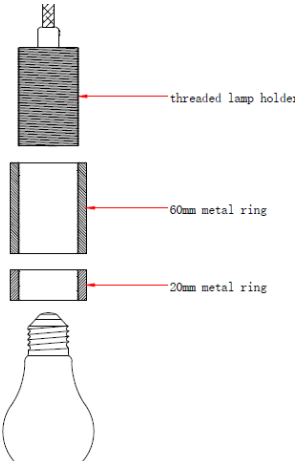
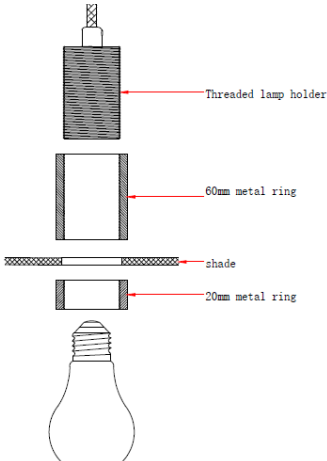
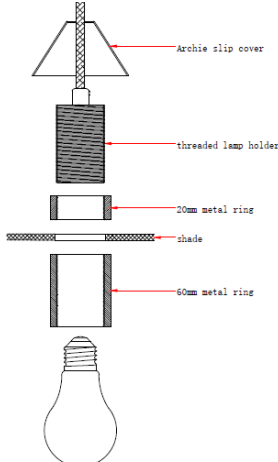
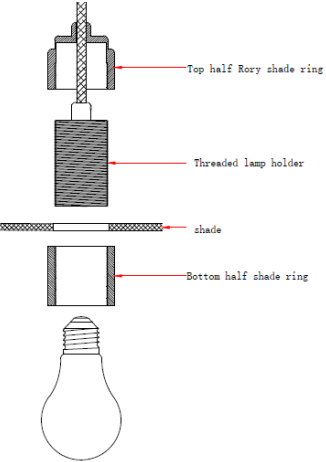
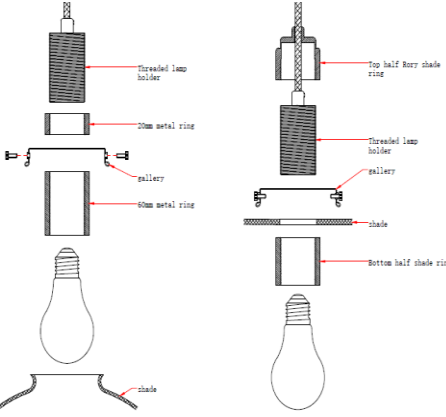
LOCKIE	FERGUS BARE BULB	FERGUS WITH SHADE
<p>2 x shade rings (7mm x 50mm)</p>  <p>The top Lockie ring should be screwed all the way up to the top of the lamp holder.</p>	<p>2 x shade rings (1: 20mm x 50mm, 2: 60mm x 50mm)</p>  <p>Use the big ring on the top and the small ring on the bottom – ensure to cover the cord grip.</p>	<p>2 x shade rings (1: 20mm x 50mm, 2: 60mm x 50mm)</p>  <p>You can have the big or small ring on the top of the shade, it is an aesthetic choice. For it to look great make sure the ring set covers the cord grip.</p>
<p>2 x Fergus shade rings plus Archie slip cover</p>  <p>Archie is an angled slipcover that sits on top of the Fergus fitting. This cover must be threaded onto the cord before installation. The 20mm Fergus ring must be on top of the shade.</p>	<p>2 x Rory shade rings (1: 45mm x 50mm with stepped top, 2: 45mm x 50mm)</p>  <p>Thread the top half of the Rory fitting onto cord and screw down on threaded lamp holder, then screw the bottom half (45mm ring) up inside the shade to secure.</p>	<p>Small gallery: 100mm w x 17mm h Big gallery: 135mm w x 25mm h</p>  <p>Our galleries are used on shades with a 'lip' to secure them -functional. They can also be used as a design feature between the ring sets - decorative.</p>