

ASSEMBLY INSTRUCTIONS FOR GLASS LEAF CHANDELIER

OPEN THE BOX AND UNPACK
ALL COMPONENTS FROM THE BOX.

- ① FRAME x 1Pc
- ② GLASS LEAVES x 54 Pcs

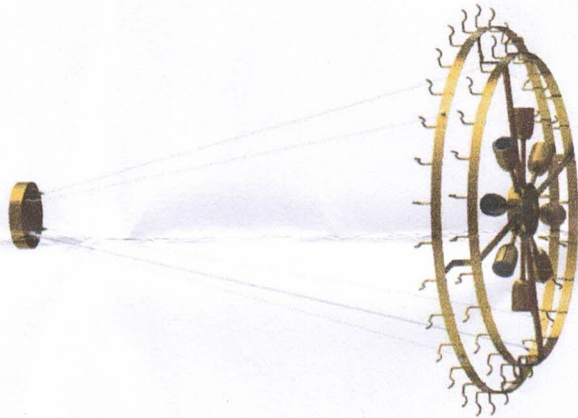

Fig.- 1

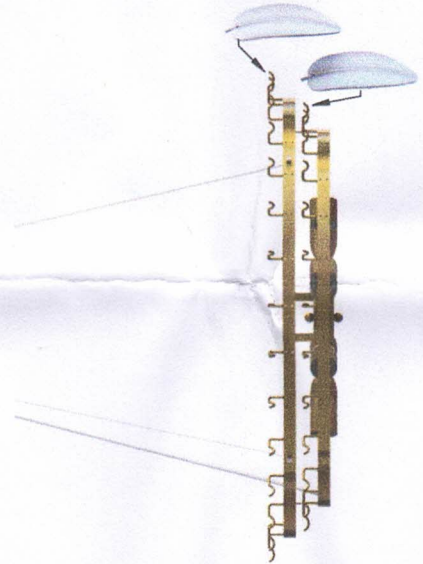
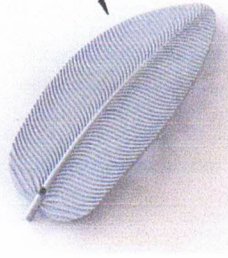

Fig.- 2

NOW ATTACH THE GLASS LEAF
INTO THE HOOK GIVEN ON FRAME
AS SHOW IN Fig.- 2 .



Glass Leaf x 54 Pcs

Fig.- 3



ONCE ALL THE GLASS LEAVES
ARE IN PLACE INSERT THE BULBS
AND YOUR CHANDELIER IS
READY FOR ELECTRICIAN TO
HANG.



Fig.- 4

NOTES- INSTALLATION OF THIS CHANDELIER MUST BE UNDERTAKEN BY A
QUALIFIED ELECTRICIAN.

Assembly Instruction for Hard Wired Pendant Light

SAFETY INFORMATION

Please read and understand this entire manual before attempting to assemble, operate or install the product

Warning

- TURN OFF ELECTRICITY at main fuse box (or circuit breaker box) before beginning installation by removing fuse (or switching off circuit breaker)

CAUTION

- This Product must be installed by a registered electrician.
- Only suitable for indoor location without wind breeze so that it does not blow the shade closer to Bulb.

PREPARATION

Before beginning assembly of product, make sure all parts are present. Compare parts with package contents list and hardware contents above. If any part is missing or damaged, do not attempt to assemble the product components. Contact customer service for replacement parts.

ASSEMBLY INSTRUCTION

- Shut off the main electrical supply from the main Fuse Box/ Circuit Breaker.
- Remove all parts from the carton. Do not throw away any parts.
- Connect live, neutral & earth wires to each other in the junction box.
- Fix support hardware directly to the ceiling.
- Install light bulbs (not included).

CARE AND MAINTENANCE

- Shut off the main power supply before wiping product with clamp cloth or window cleaner. Do not use abrasives.

Step 1

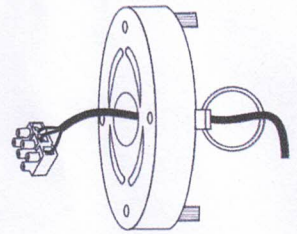

Step 2

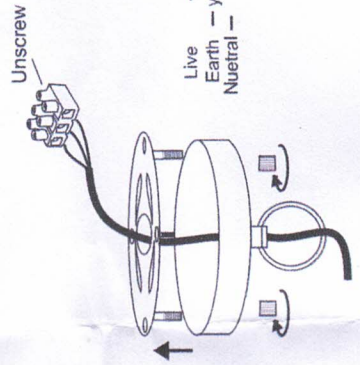

Step 3

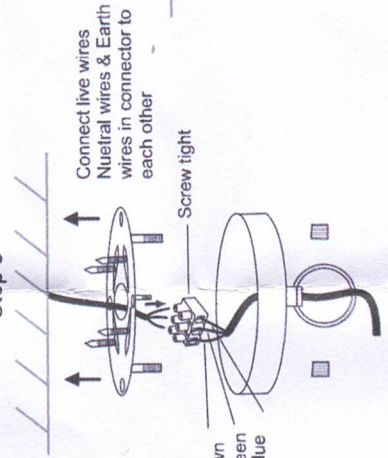

Step 4

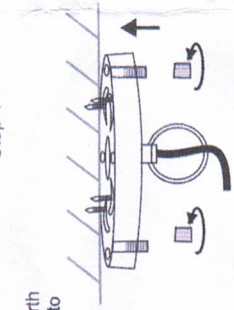

Step 5

